

BLACK

H.264 Network IP Camera

Quick Installation Guide

This document guides you through the basic steps to install and configure your Digiop® Black BLK-IP5103 IP camera. For detailed instructions, refer to the user manual.

Find the camera's **MAC address** on the product label and enter it here: _____

Step 1. Install the camera

Install the camera mounting bracket using the instructions provided with the bracket.

Attach the adapter for mounting the camera to side with the label or to the opposite side with the four screws provided.

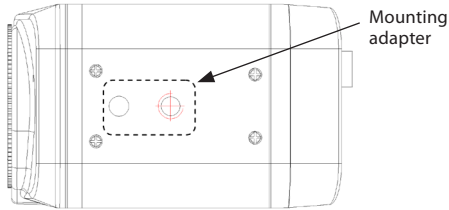

Remove the protective cap covering the camera CCD.

Attach the lens assembly to the camera by screwing it clockwise onto the camera until it is fully seated. The lens may require a mounting ring adapter to fit onto the camera.

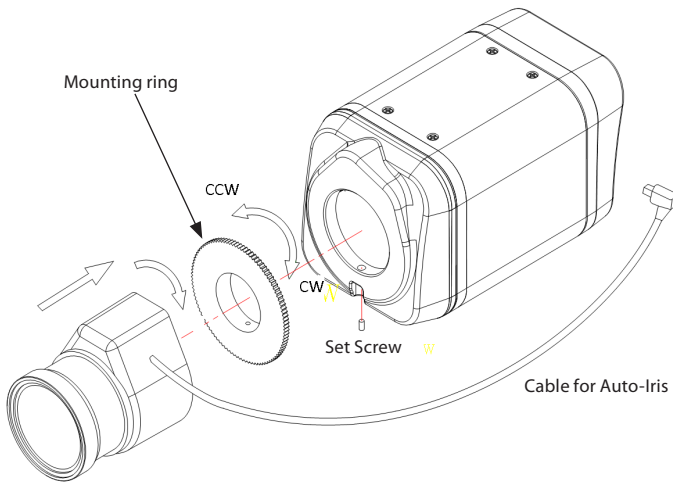

Tighten the lens set screw with the hex wrench provided.

If the lens assembly has an Auto Iris feature, attach the lens cable to the 4-pin connector on the back of the camera.

Attach the camera to the mounting bracket.

CONNECTIONS

Connections to the camera for audio in and out (microphone and speaker), D/I sensor, alarm, and RS-485 control are made through the 9-pin terminal block. Plug the terminal block into the mating connector on the camera.

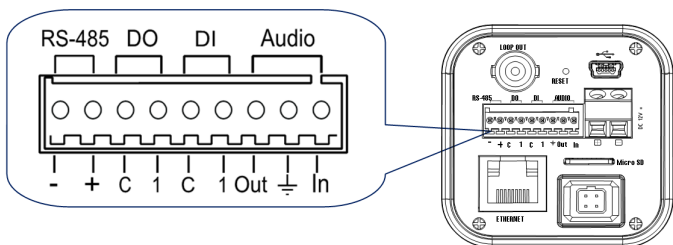

Attach peripheral devices to the terminal blocks as needed. For detailed interface specifications, refer to the user manual.

Step 2. Connect the camera to the LAN

Attach the network LAN cable to the Ethernet connector on the camera backpanel.

Your camera can be powered locally with a 12 V DC adapter, or across the LAN (PoE). If using the power adapter, attach the DC jack adapter cable to the DC 12V power adapter terminals on the back of the camera. Connect the red wire of the adapter cable to the + terminal, and the black (or white) wire to the - terminal. **DO NOT apply power** to the camera at this time.

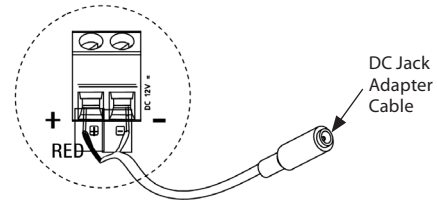

Step 3. Install IPAdmin Tool

The IPAdminTool is a utility for configuring the network settings of your Digiop Black cameras and installing new firmware. It can be loaded on a Microsoft Windows XP, Vista or Windows 7 operating system. At a computer on the same LAN (subnet) where your cameras will be installed, do the following:

1. Insert the CD mini disk provided with your camera into your computer's CD ROM drive and open the CD in a Windows Explorer window.
2. Find the IPAdminTool directory on the CD.
3. Copy the IPAdminTool directory with its contents to your computer hard drive.

Step 4. Configure the network settings of you camera

When your IP camera is attached to a network and initially powered on, it attempts acquire compatible network settings from a DHCP server. If it cannot find a DHCP server, it configures itself with the following static (fixed) settings, which may or may not be compatible with other devices on the network.

IP address: 192.168.0.100
 Subnet mask: 255.255.255.0
 Gateway: 192.168.0.1

Your camera must be configured with static network settings that are compatible with the LAN. If your LAN has a DHCP server, use the following sub-step. Otherwise, use the sub-step procedure below for **LANs without DHCP**.

Installing cameras on LANs with DHCP

1. Connect your camera to the LAN, then power on the camera.
2. Open the IPAdminTool directory on your computer, then double click the file **IPAdminTool.exe** to start the application. When the IPAdmin Tool starts, it will discover all the IP devices it supports that exist on the network. The discovery process may take a few minutes.

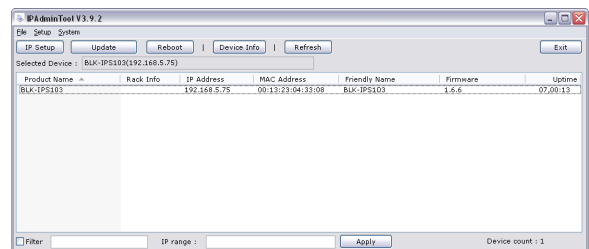

Review the list of IP devices found by IPAdmin Tool. You can identify your camera by the MAC address. If the camera was not found, click the **Refresh** button every minute until your camera appears in the list.

3. After finding your camera, right click the entry, then select **IP Address** from the drop-down list. An IP Setup window will open.

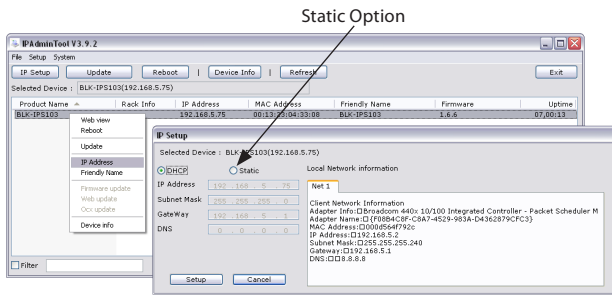

4. In the IP Setup window, click the **Static** option bullet. If you have other compatible network settings you want to apply to the device, enter them in the appropriate locations. Click **Setup** to save settings.
5. In the **Login** window, enter the ID and PW (password) for your camera, then click **Login**. The default administrator values for the ID and PW are **root** and **pass**.
6. In the IPAdmin Tool window, click **Refresh**. Verify that the entry representing the camera now shows the (new) static IP address.
7. Continue with procedure **Step 5. Setup camera Basic Configuration**.

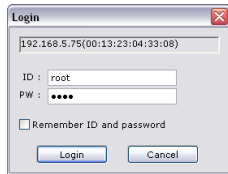

Installing cameras on LANs without DHCP

NOTE *The following procedure works with most networks. For further assistance, contact Technical Support.*

In networks without a DHCP server, cameras must be powered on and reconfigured one at a time to avoid addressing conflicts between other cameras, or possibly with another device on the network. Configuring the network settings of your cameras includes these steps:

- Determine the network settings of your computer.
- Check the network for compatibility with the default static network settings of your camera.
- Find an IP address that is not in use and can be assigned to your camera.
- Attach your camera to the network, power it on, and configuring it with new network settings.

Determine the network settings of your computer

1. At a PC attached to the LAN where your camera will be connected, determine the IP address, subnet mask, and default gateway of your PC. To find this information:
 - a. Hold down the **Windows** key and press **r** to open the Run dialog box.
 - b. Type **cmd** in the entry field, then click **OK** to open the Command Prompt window.
 - c. At the command prompt, enter **ipconfig**. The response will show your PC's network settings.

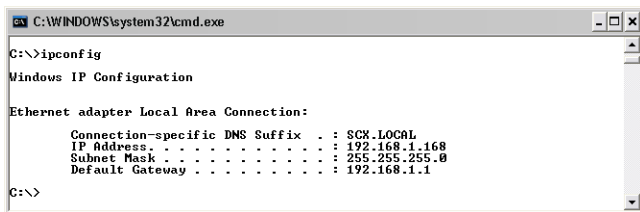
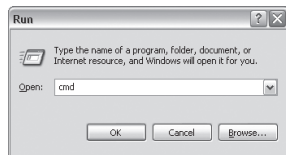

- d. Record the IP Address, Subnet Mask, and Default Gateway for your PC's Ethernet adapter for future reference.

NOTE

The Ethernet adapter data you see by using ipconfig will probably be different from that shown in the example above. If you are using Windows Vista or Windows 7, the IP address is identified as the "IPv4 Address."

Check LAN for default IP address compatibility

Before connecting your camera to the LAN, check the network to see if IP address 192.168.0.100 is already in use. At a Microsoft Windows computer attached to the LAN where the camera will be connected, open a Command Prompt window and enter:

ping 192.168.0.100

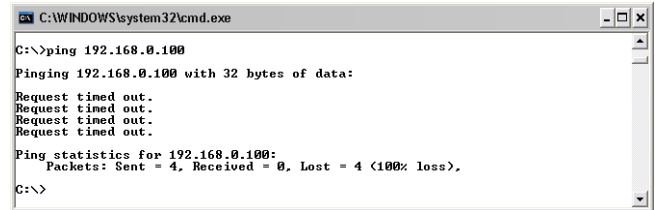

The "**Request timed out**" response indicates that the IP address is not in use and the camera can be connected without causing conflicts. If the response from the ping command received a "**Reply..**", the IP address is in use. Contact Technical Support for further assistance, if needed.

Find network settings (IP addresses) that are not in use

1. At your PC, find an IP address on your network that is not in use:
 - a. Write down the EXACT IP address of your PC up to the third/last period. Using the example shown above, this expression is: 192.168.1. After the third period, include any number between 1 and 254 that is different from the one in your PC's IP address, 168. As a first try, let's choose 200, which will form the IP address 192.168.1.200.
 - b. Next, use the **ping** command in the Command Prompt window to see if this IP address is in use on your network. Enter:

ping 192.168.1.200

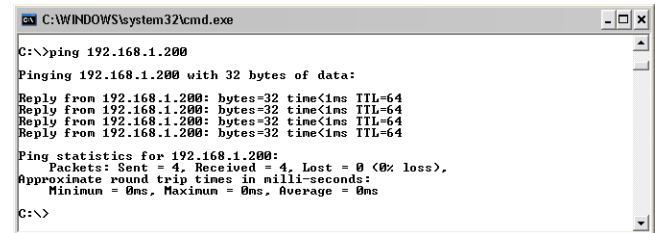

In the example shown above, the message "**Reply from 192.168.1.200: ..**" indicates that your PC can reach a device with that IP address, and that address is in use (i.e., you cannot use it for your camera).

- c. Since the **ping** test showed that 192.168.1.200 is in use, try another number between 1 and 254. Let's try to ping 192.168.1.201. At the command prompt, enter: **ping 192.168.1.201**

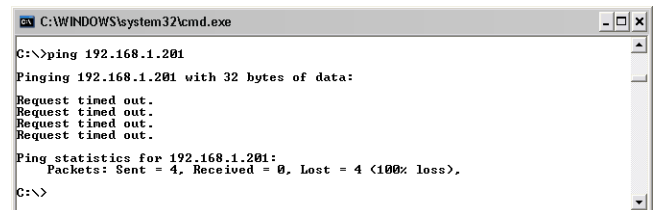

- d. In this test, the message "**Request timed out**" indicates that your PC cannot reach the device with that IP address, and that address is probably not in use. If this test showed that this IP address is in use, try other IP addresses using the steps above until an unused address is found.

Attach your camera to the network, power it on, and configuring it with new network settings

1. Connect the camera to the LAN and apply power to the camera. Wait until the initialization process completes (2 to 4 minutes) before continuing.
2. Open the IPAdminTool directory on your computer, then double click the file **IPAdminTool.exe** to start the application. When the IPAdmin Tool starts, it will discover all the IP devices it supports that exist on the network. The discovery process may take a few minutes.
3. In the Product list, find the entry with the same MAC address as the camera you installed. If the camera is not shown, click **Refresh** once a minute to update the list.
4. Right click on the entry for your camera and select **IP Address**.

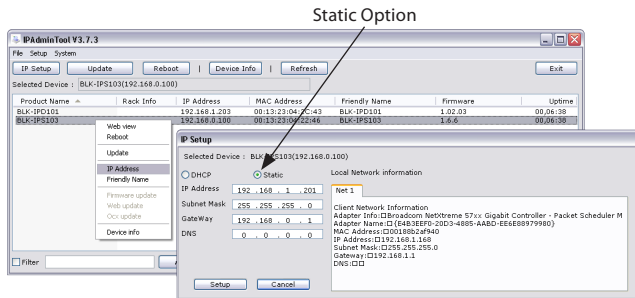

5. In the IP Setup window:
 - a. Select the **Static** option if it is not selected.
 - b. Enter the new IP address for your camera into the IP Address field.
 - c. Enter the subnet mask of your computer into the Subnet Mask field.
 - d. Enter the gateway of your computer into the Gateway field.
6. Click **SETUP**. A Login window will open.



6. In the **Login** window, enter the ID and PW (password) for your camera and click **Login**. The default administrator values for the ID and PW are **root** and **pass**.
7. In the IPAdmin Tool window, click **Refresh**. Verify that the entry representing the camera now shows the new IP address.

Step 5. Setup camera Basic Configuration

To view video images from the camera, at a computer attached to the LAN where the camera is installed, open Microsoft® Internet Explorer and go to:

<http://<IP address of the camera>>

If the IP address is 192.168.1.201, enter: <http://192.168.1.201>

If prompted to install ActiveX controls such as AxAll.cab (publisher Cap Co), AxPTZ, or AxNVC, follow screen prompts to install the software.

This website wants to install the following add-on: 'AxAll.cab' from 'Cap Co'. If you trust the website and the add-on and want to install it, click here...

NOTE To load these ActiveX controls, you may need to adjust the security settings of your browser to accept add-ins from unknown publishers.

After logging into your camera, if you cannot see live video from the camera and the message: "Can not Create XMLDOMDocument Install MSXML4.0" appears, download and install the MS XML 4.0 library. This library can be found at:

<http://www.microsoft.com/downloads/details.aspx?familyid=3144B72B-B4F2-46DA-B4B6-C5D7485F2B42&displaylang=en>

After the camera VIEW screen appears, click **SETUP** and enter the default User name and Password, **root** and **pass**.

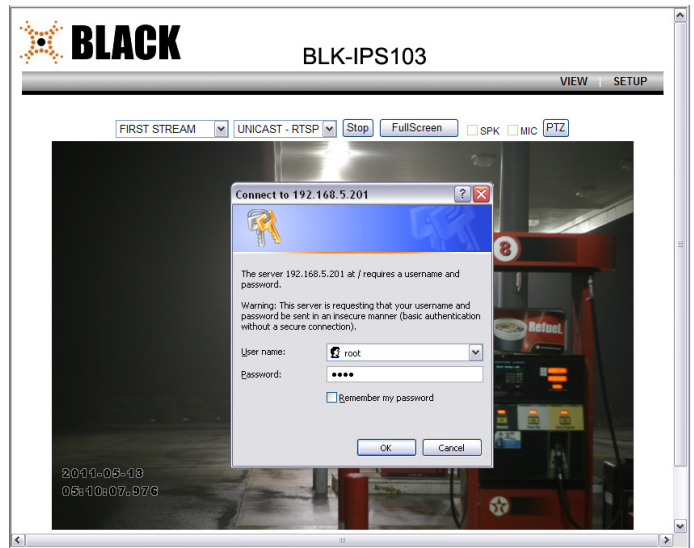

In the SETUP window, go to **Basic Configuration > Users**.

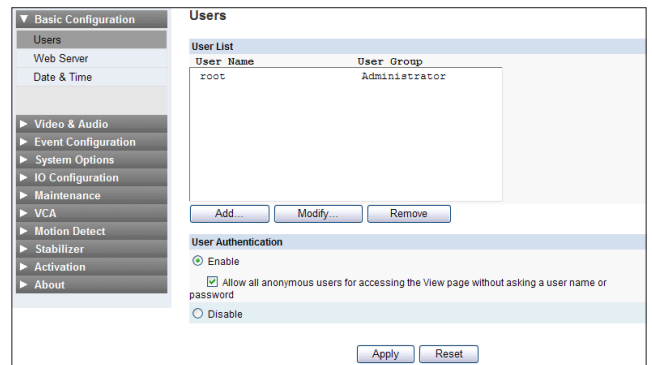

In the User list, click **root** to highlight it, and then click **Modify**. Enter a new password and click **OK**. In the Users screen, click **Apply**, and then click **OK** to restart the server.

Go to **Basic Configuration > Date & Time**.

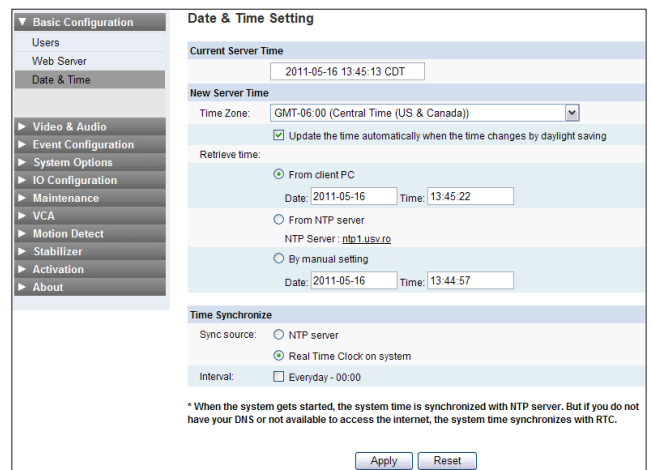

On the Date & Time screen, set the Time Zone, Method, and Time Synchronization options. Click **Apply**.

Click **VIEW** to exit SETUP mode and return to the web viewing screen.

AIM AND FOCUS THE CAMERA

Set focus and zoom while observing video image from the camera. Video is provided through a web browser, and by attaching a local video monitor to the LOOP OUT BNC connector on the back of the camera. Use the documentation provided with your camera mounting bracket and lens to make these adjustments.